

Tech Tips:

TR328 –Wheel Arch Padding Interior Upholstery

Background: The interior covering of the wheel arches originally included a padding on top of the wheel arch to “soften” the touch and aid in the install. A study of this padding revealed that it was a felt type padding. There have been noted examples of the padding also being on the side of the wheel arch showing an inconsistency during production. Therefore, one has to assume that it depended on who was doing the interior install on a given day at Abingdon as to whether just the top or both top and side.

Today: This padding set is recommended to be installed on the wheel arch both top and side. This will best replicate the soft touch and provide an excellent sub-surface for professionally looking install of the interior vinyl. The following diagram shows how to layout the pieces need for install.

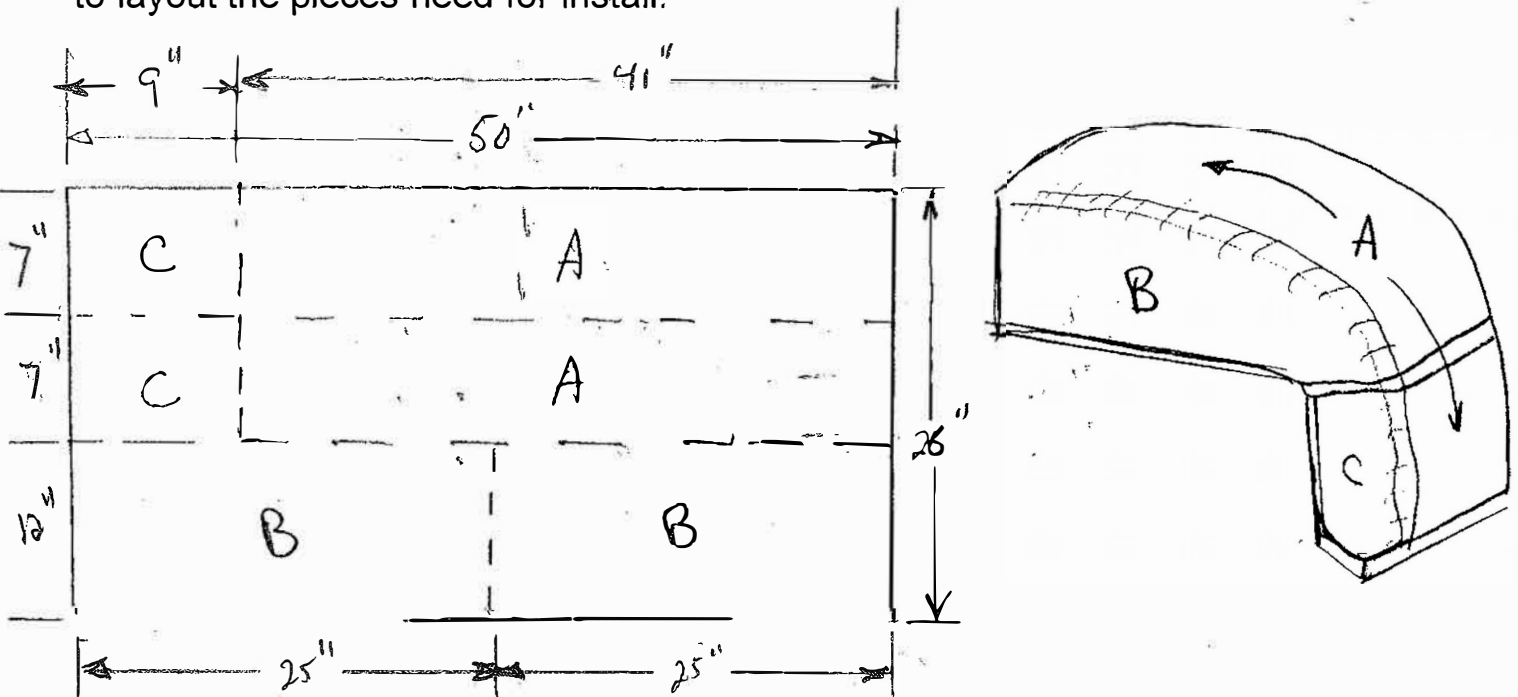

SAFETY FAST!